

Article number: 0105072
 Description: Retaining ring AV 55
 Note: Fitted with ZGA pliers

Measures

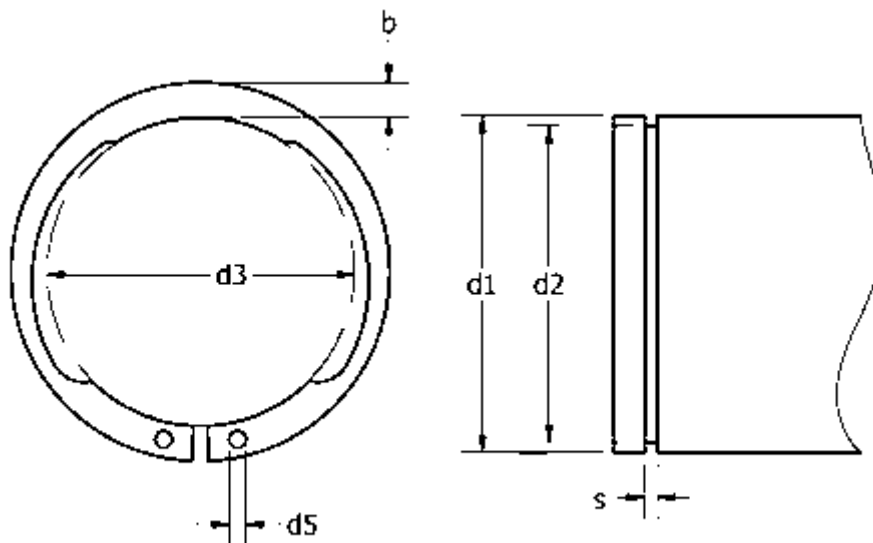

AN mm ²	= 126.0	FRg kN	= 9.3	t	= 1.50
b	= 5.8	FR kN	= 58.0	tol	= -0.07
d1	= 55	g	= 2.5	tol	= -0.30
d2	= 52.0	K kN-mm	= 104.0	tol	= +0,46-1,10
d3	= 50.80	m min	= 2.15	tol	= 0.2
d5 min	= 2.5	n abl x 1000	= 9	Tong	= ZGA-3
Description	= AV 55	s	= 2.00	Weight kg/1000	= 11.42
FN kN	= 21.00	Side power N at I2	= 4.5		